

Experience more efficient heat transfer solutions in your District energy application

The list of applications that operate more efficiently with compact brazed heat exchangers, BPHEs, is a long one: boilers, steam, snow melting, floor heating, solar panels, cooling towers, district heating, district cooling and sanitary water applications. New applications are added constantly, and today you will find SWEP BPHEs in virtually all kinds of solutions in the global market. Alongside the increase in the areas of use, there is also a rapid technological changeover to modern high-efficiency SWEP BPHEs where traditional rubber-gasketed plate heat exchangers and shell-and-tubes were previously used. Extensive research and development combined with effective use of CFD (Computational Fluid Dynamics) have enabled us to offer the market's most comprehensive range of products for all types of heat transfer applications. And by using standardized components, we can cost-effectively mass customize the product precisely to your needs. We can always offer you more, thanks to our complete program of effective aids. SSP, the SWEP Software package that we have developed for dimensioning exchangers and dynamic drawing generation, is the soft way to get hard facts. Or why not do some indepth reading in advanced heat transfer theory in one of our handbooks? Contact one of our expert heat transfer consultants today to find out more about SWEP BPHEs and more efficient heat transfer solutions.



Simulation is one of the most important stages in the development of new and existing BPHEs. The ability to evaluate different plate patterns by simulating flow rate and directions offers great opportunities for improved functionality.



Each SWEP BPHE is delivered with full traceability and verified functionality. A SWEP BPHE is approved by leading independent international bodies, such as PED, UL, KHK and CSA.



Heating applications

Our "Technical Handbook about Heating Applications" offers you every opportunity to broaden your competence, with first-class information about everything from basic heat transfer to gas boilers and district heating systems.

Challenge efficiency

At SWEP, we believe our future rests on giving more energy than we take – from our planet and our people. That's why we pour our energy into leading the conversion to sustainable energy usage in heat transfer. Over three decades, the SWEP brand has become synonymous with challenging efficiency.

SWEP is a world-leading supplier of brazed plate heat exchangers for HVAC and industrial applications. With over 1,000 dedicated employees, carefully selected business partners, global presence with production, sales and heartfelt service, we bring a level of expertise and customer intimacy that's redefining competitive edge for a more sustainable future. SWEP is part of Dover Corporation, a multi-billion-dollar, diversified manufacturer of a wide range of proprietary products and components for industrial and commercial use.

Printed on 100% recycled paper. SWEP is an ISO 14001 Certified company.

swep.net















SWEP
A DOVER COMPANY









CHALLENGE EFFICIENCY

Brazed plate heat exchangers for District energy applications

SWEP
A DOVER COMPANY

A complete range of dedicated BPHEs for District energy applications

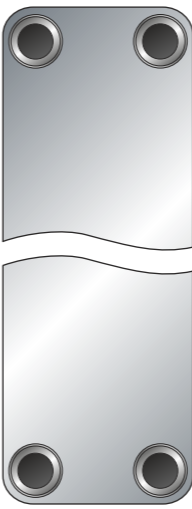
E5AS		E5T		5		E8AS		E8LAS		E8T		B8T		B8LAS		B10T		B12		B15T		B16		B16DW		B35T		B35TDW			
Dimension	73x192 mm 2.87x7.56 inch	Dimension	73x192 mm 2.87x7.56 inch	Dimension	72.5x187.5 mm 2.85x7.38 inch	Dimension	74x315 mm 2.91x12.4 inch	Dimension	74x316 mm 2.91x12.44 inch	Dimension	74x315 mm 2.91x12.4 inch	Dimension	76x317 mm 2.99x12.48 inch	Dimension	76.2x317.7 mm 3x12.51 inch	Dimension	76.2x317.7 mm 3x12.51 inch	Dimension	119x289 mm 4.68x11.37 inch	Dimension	117x287 mm 4.60x11.29 inch	Dimension	72x468 mm 2.83x18.42 inch	Dimension	119x376 mm 4.69x14.8 inch	Dimension	119.5x377 mm 4.70x14.85 inch	Dimension	243x393 mm 9.57x15.47 inch	Dimension	243x393 mm 9.57x15.47 inch
Weight	0.29+0.044x(NoP-2) kg 0.63+0.097x(NoP-2) lb	Weight	0.29+0.044x(NoP-2) kg 0.63+0.097x(NoP-2) lb	Weight	0.30+0.040xNoP kg 0.67+0.088xNoP lb	Weight	0.45+0.059x(NoP-2) kg 1.00+0.130x(NoP-2) lb	Weight	0.42+0.059x(NoP-2) kg 0.93+0.130x(NoP-2) lb	Weight	0.45+0.059x(NoP-2) kg 1.00+0.130x(NoP-2) lb	Weight	0.85+0.075x(NoP-2) kg 1.88+0.165x(NoP-2) lb	Weight	1.14+0.096xNoP kg 2.51+0.21xNoP lb	Weight	0.84+0.059xNoP kg 1.85+0.130xNoP lb	Weight	1.17+0.120xNoP kg 2.58+0.26xNoP lb	Weight	1.17+0.120xNoP kg 2.58+0.26xNoP lb	Weight	1.25+0.104xNoP kg 2.76+0.229xNoP lb	Weight	1.48+0.120xNoP kg 3.25+0.265xNoP lb	Weight	1.62+0.22xNoP kg 3.57+0.48xNoP lb	Weight	15.8+0.256xNoP kg 34.7+0.564xNoP lb	Weight	12.3+0.494xNoP kg 27.1+1.089xNoP lb
Max NoP	40	Max NoP	40	Max NoP	60	Max NoP	42	Max NoP	70	Max NoP	42	Max NoP	60	Max NoP	70	Max NoP	140	Max NoP	140	Max NoP	140	Max NoP	140	Max NoP	140	Max NoP	260	Max NoP	260		

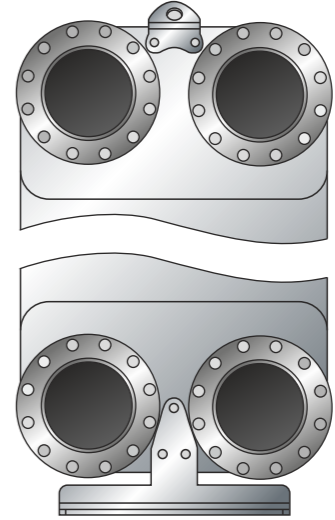
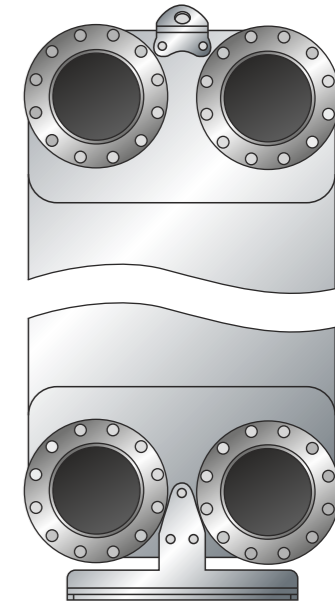
B28		B80		B80AS		B85		B86		B220		B320HT		B320LT		B427		B439		B633		B649			
Dimension	119x526 mm 4.69x20.71 inch	Dimension	119x526 mm 4.69x20.71 inch	Dimension	119x526 mm 4.69x20.71 inch	Dimension	119x526 mm 4.69x20.71 inch	Dimension	119x526 mm 4.69x20.71 inch	Dimension	202x524 mm 7.95x20.63 inch	Dimension	243x525 mm 9.57x20.67 inch	Dimension	243x525 mm 9.57x20.67 inch	Dimension	304x694 mm 11.97x27.32 inch	Dimension	304x979 mm 11.96x38.54 inch	Dimension	537x830 mm 21.14x32.68 inch	Dimension	537x1232 mm 21.14x48.50 inch	Dimension	537x1232 mm 21.14x48.50 inch
Weight	2.09+0.164xNoP kg 4.61+0.362xNoP lb	Weight	2.09+0.164xNoP kg 4.61+0.362xNoP lb	Weight	2.09+0.164xNoP kg 4.61+0.362xNoP lb	Weight	2.09+0.137xNoP kg 4.61+0.301xNoP lb	Weight	2.09+0.137xNoP kg 4.61+0.301xNoP lb	Weight	12.1+0.321xNoP kg 26.7+0.708xNoP lb	Weight	9.61+0.389xNoP kg 21.19+0.858xNoP lb	Weight	13.1+0.432xNoP kg 28.9+0.952xNoP lb	Weight	21.9+0.590xNoP kg 48.3+1.301xNoP lb	Weight	15.7+0.890xNoP kg 34.7+1.962xNoP lb	Weight	80.3+1.224xNoP kg 177.1+2.698xNoP lb	Weight	101.27+1.941xNP 223.2+4.27xNoP lb	Weight	101.27+1.941xNP 223.2+4.27xNoP lb
Max NoP	140	Max NoP	140	Max NoP	140	Max NoP	160	Max NoP	160	Max NoP	300	Max NoP	300	Max NoP	260	Max NoP	420	Max NoP	420	Max NoP	320	Max NoP	420		

The concept

In principle, a BPHE is constructed as a plate package of corrugated channel plates between front and rear cover-plate packages. The cover plate packages consist of sealing plates, blind rings and cover plates. During the vacuum-brazing process, a brazed joint is formed at every contact point between the base and the filler material.

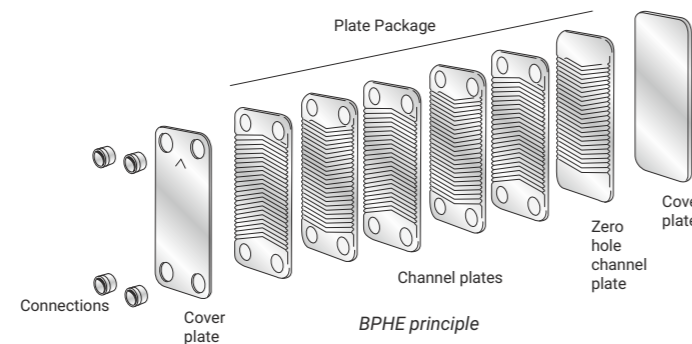

The fluids can pass through the heat exchanger in different ways. For parallel flow BPHEs, there are two different flow configurations: co-current or counter-current.

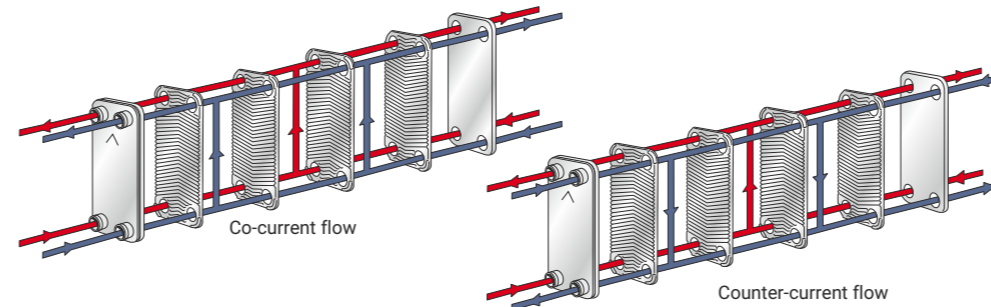

There are several different versions of the channel plate packages. The right illustration is just one example.

